

TAC 41

Lite

user manual



TAC 41

Lite



TABLE OF CONTENT

SAFETY.....	4
WARNINGS.....	4
BOX CONTENT.....	5
GUN DESCRIPTION.....	5
FIRST ASSEMBLY.....	6
SAFETY OPERATION.....	7
MAGAZINE OPERATION.....	7
FEEDING RAMP INITIALIZATION.....	8
SHOOTING OPERATION.....	8
FEEDING RAMP RESET.....	9
HOPUP ADJUSTMENT.....	10
ADVANCED SETTINGS & ERGONOMICS.....	11
EXPLODED VIEWS.....	12
MATERIALS/MASS/SIZE/CAPACITY.....	13
DIGITAL VERSIONS.....	14



TMC

SAFETY

READ THIS MANUAL CAREFULLY AND THOROUGHLY BEFORE USE, users should obey to laws regarding the usage and ownership of airsoft guns in their country. Misuse or careless use may cause serious injuries. Always treat airsoft guns as if they are loaded and with the same respect as you would treat firearms. Do not look into an airsoft gun muzzle. Never point the airsoft gun at something you do not intend to shoot. Users should always wear safety glasses. Always carry the airsoft gun in a bag or a case and never display it in public places. Always keep the airsoft gun in "safe" mode until you are ready to shoot at a safe direction. Always check that the airsoft gun is in "safe" mode and unloaded when getting it from another person or from storage. Do not put the airsoft gun away or in storage while it is still loaded. Do not shoot at hard surfaces or water surfaces as BBs could bounce or ricochet and hit someone or something you do not intend to hit. Always use high quality 6 mm plastic BBs and never use already shot BBs as it may damage your airsoft gun. Always store airsoft guns in a secure place and out of reach from children. Do not attempt to modify or alter your airsoft guns, as doing so may make your airsoft gun unsafe to use and/or cause serious injuries and/or void the warranty.

WE ARE NOT RESPONSIBLE FOR ANY MALFUNCTIONS, ACCIDENTS, INJURIES OR REPAIR COSTS RESULTING FROM MISUSE, DISASSEMBLY AND/OR MODIFICATION OF THIS AIRSOFT GUN.



WARNINGS

- The feeding ramp can hold 20 BBs, that means the Tac-41 is able to shoot without a magazine.
- Do not pull the trigger while the bolt is not locked or you will damage the receiver.
- While changing magazine, if the magazine it's not empty, you will lose 1 to 2 bbs. To avoid losing any bbs, remove the magazine only when it's empty.
- Do not loosen the 3 barrel screws too much while changing the barrel or you will deform the stock.
- In case of inner barrel disassembly, do not overtighten the lateral screws or you will damage the inner barrel.
- It is almost impossible to remove the hopup rubber without tearing it: do not attempt to disassemble the hopup rubber if you are not going to replace it.
- Using the trigger adjustments at maximum will generate safety problems and slamfire problems.
- Do not overload the magazine or you may damage the magazine.
- Maximum torque for the 3 barrel screws is 4 Nm (aluminium receiver) or 1 Nm (polymer receiver).
- For storage, empty the feeding ramp and keep the steel parts greasy to avoid rusting.
- Do not apply any grease/oil inside the hopup and/or the barrel.
- Keep the bolt closed during barrel changes to ensure perfect bolt and barrel alignment.
- Make sure no BBs remain in the hopup and the feeding ramp before removing the barrel.

The model depicted in this user manual is a TAC-41 Lite Sport OD. Your TAC-41 Lite may look slightly different.



BOX CONTENT

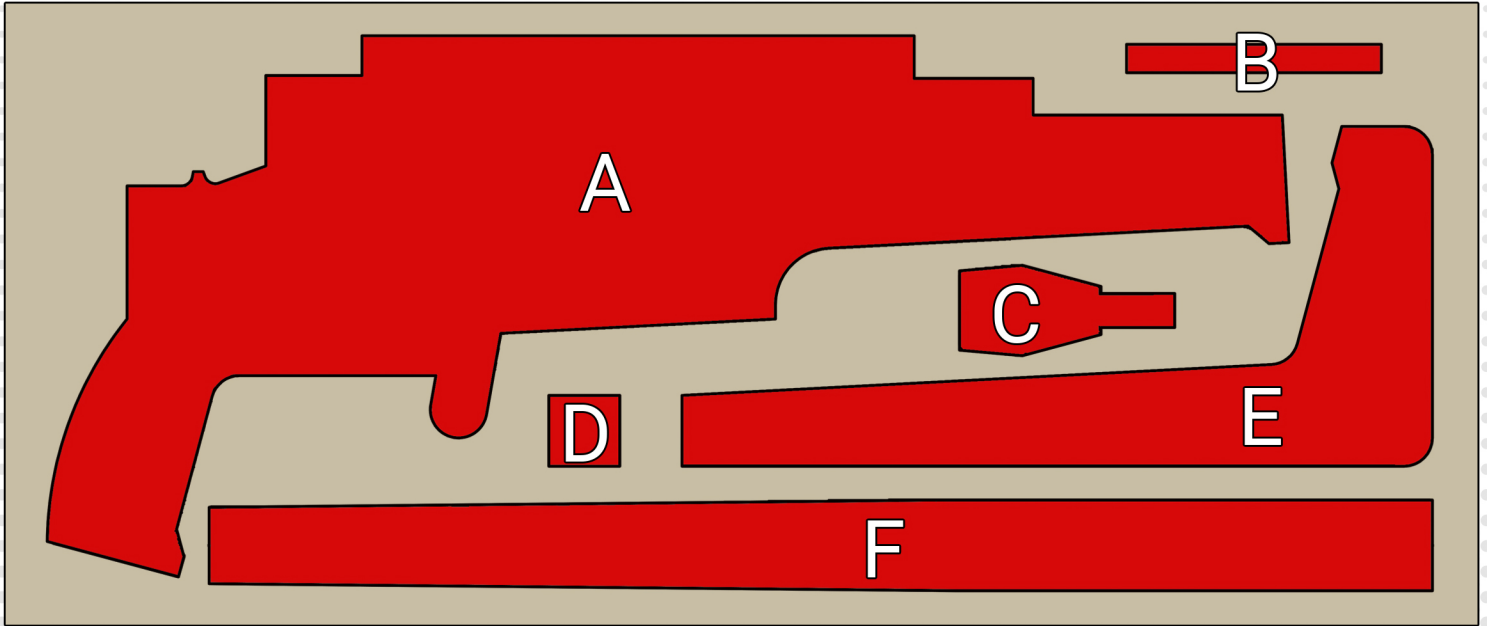

- A: TAC 41L & short magazine (engaged)
- B: Tools
- C: Bolt handle
- D: Coupler
- E: Stock
- F: 330mm barrel

Depending on your country, an additional spring may have been added in the box.

GUN DESCRIPTION

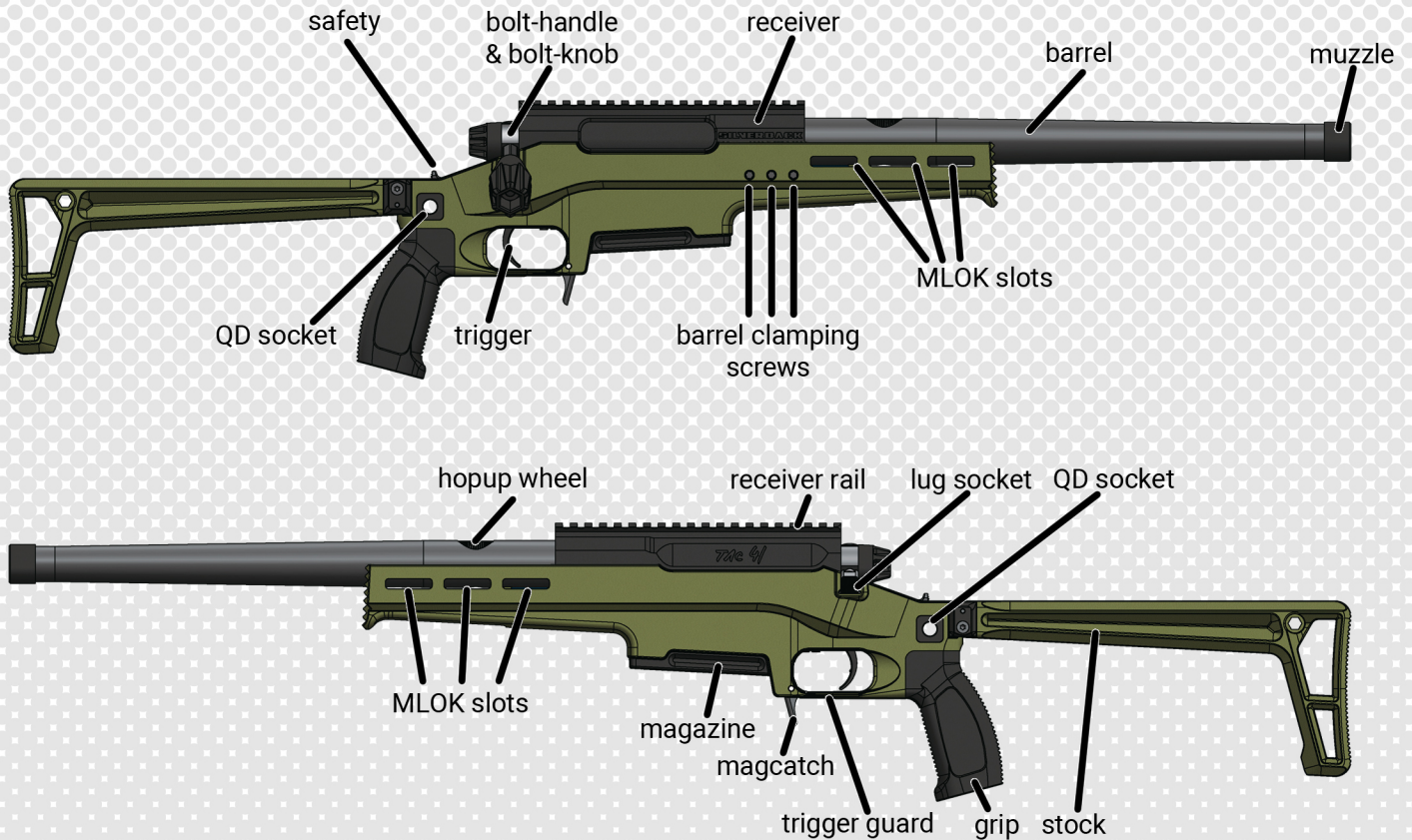

FIRST ASSEMBLY

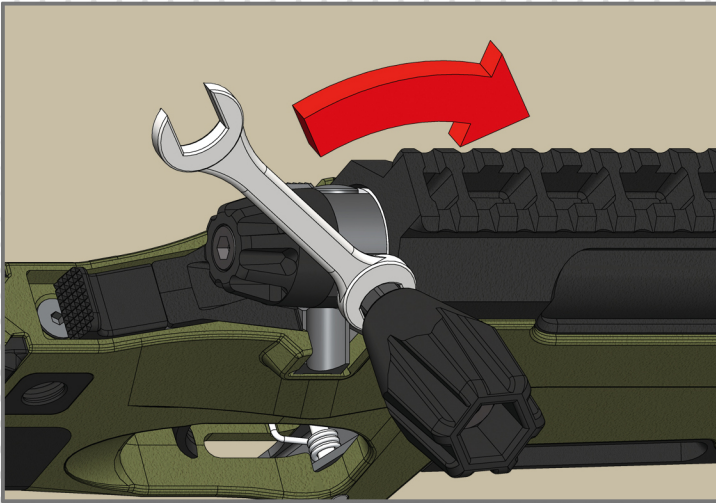

Tighten the bolt handle to the cylinder.
For better results, use a 10mm wrench and threadlock.

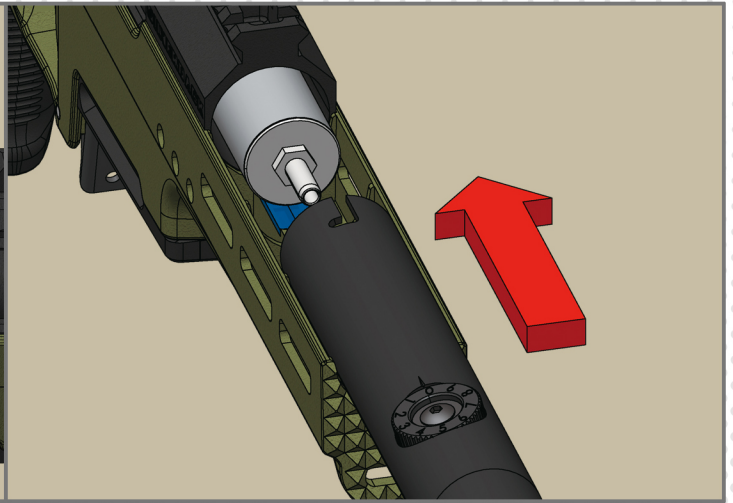

Assemble the barrel, please pay attention to the slot opening and line the slot with the pin at the top of the receiver.

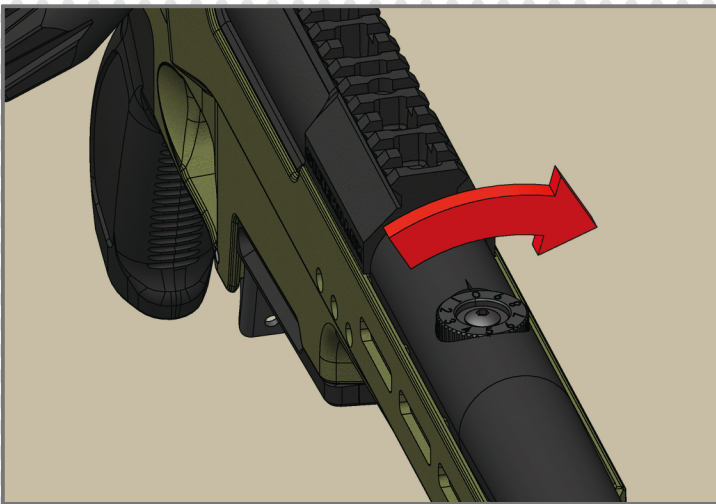

Once the barrel is slotted in, rotate in the above direction to lock the barrel in place.



Tighten the barrel screws with respect to the above order of sequences. Maximum torque: 1 Nm, finger tighten only.

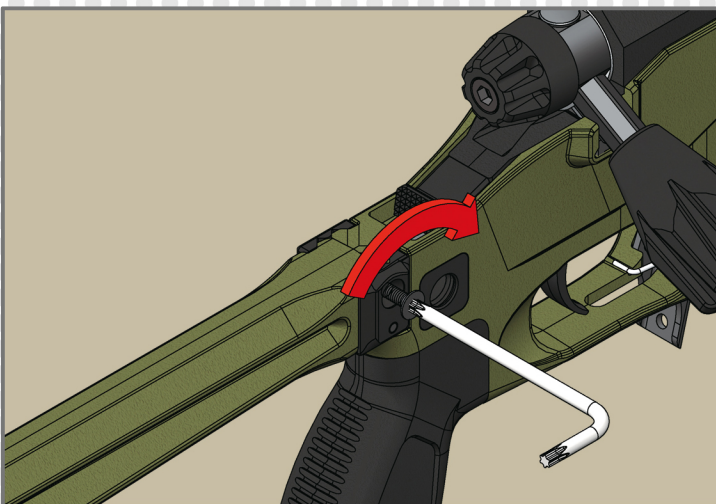

Use a Torx T20 screwdriver to tighten the stock to the gun body.

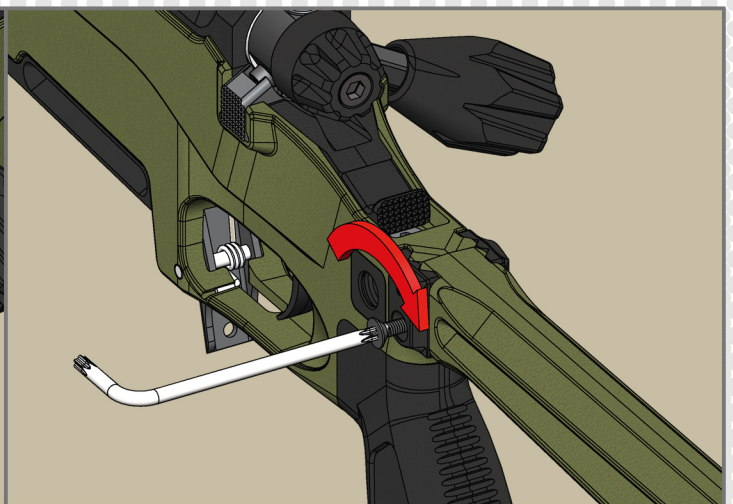

Please do the same to the other side of the gun as well.

SAFETY OPERATION

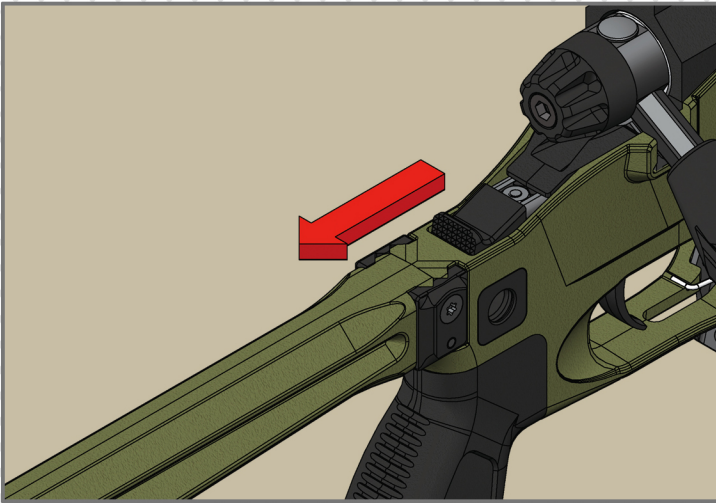

Slide the safety button towards the back to engage safety. Safety engagement may be firm when the rifle is new.

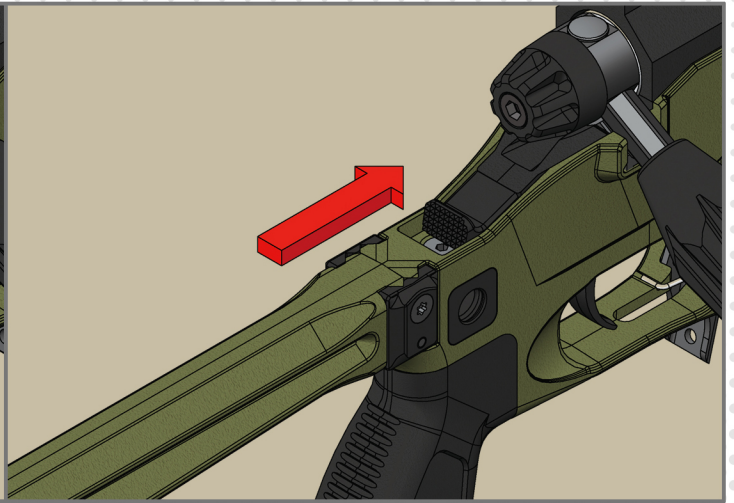

Slide the safety button towards the front to disengage the safety.

MAGAZINE OPERATION

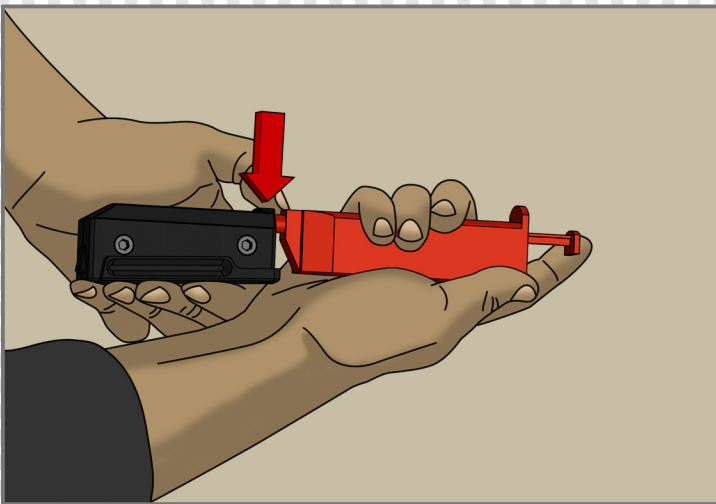

Fill the magazine with 6mm bbs, preferably using a bb-loader. You will need to press on the magazine gate (as shown) to load the magazine. Magazine capacity: 48 bbs.

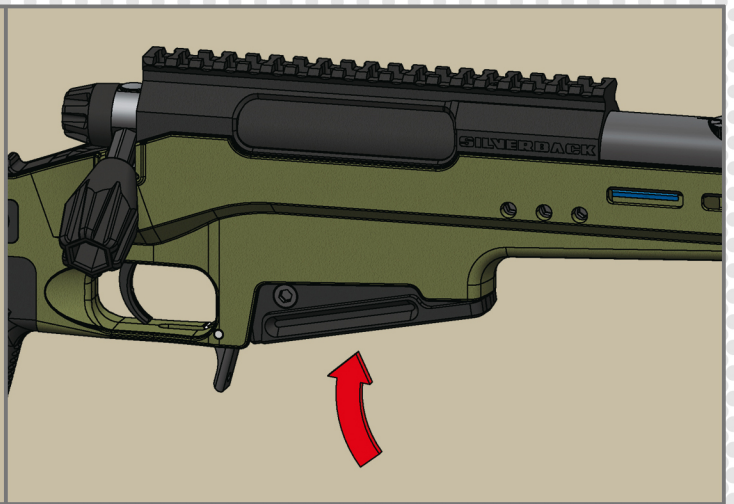

Insert the magazine as shown.

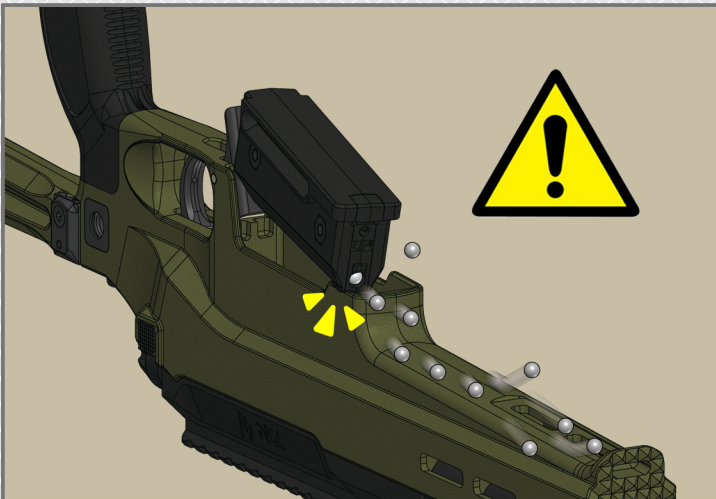

When engaging the magazine, be careful not to hit the mag gate on to the trigger guard, or else all the bbs will burst out of the magazine.



To disengage the magazine, push forward the magcatch and let the magazine drop by gravity.

FEEDING RAMP INITIALIZATION

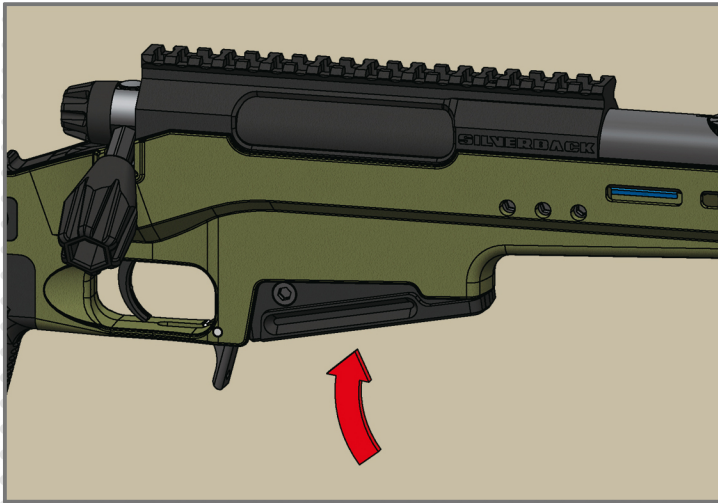

Engage a loaded magazine to pre-fill the feeding ramp (20 bbs are required).



Disengage the magazine.

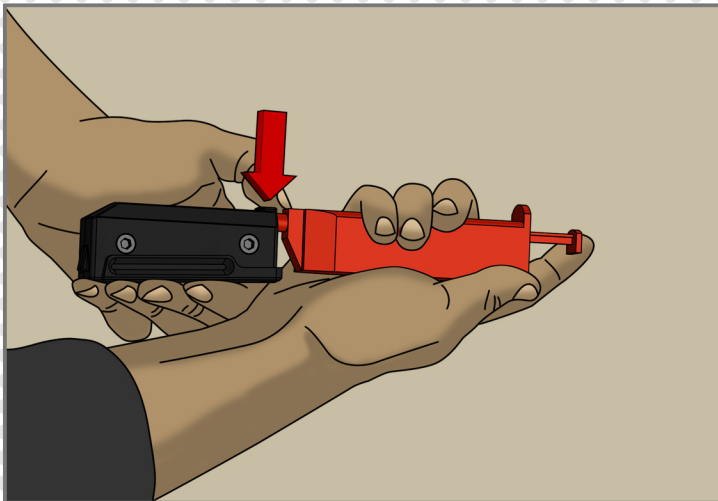

Refill the magazine.

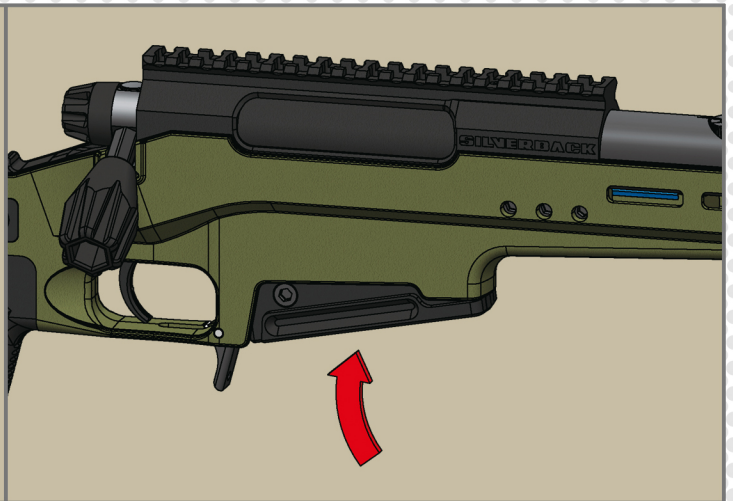

Re-engage the magazine. Your TAC-41 is now ready to shoot.

SHOOTING OPERATION



Lift up the bolt handle (make sure the bolt is not already loaded to avoid double feeding).

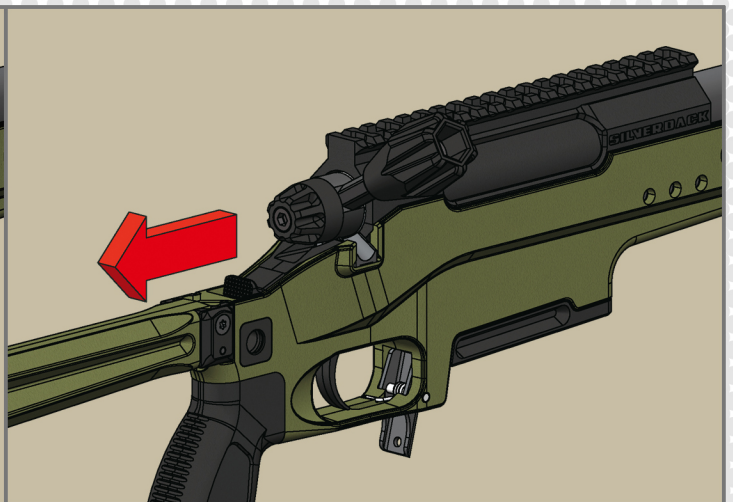

Pull the bolt backwards to compress the spring and lock the piston sear (until it clicks).



Make sure not to pull the trigger by accident when the bolt is pulled back.

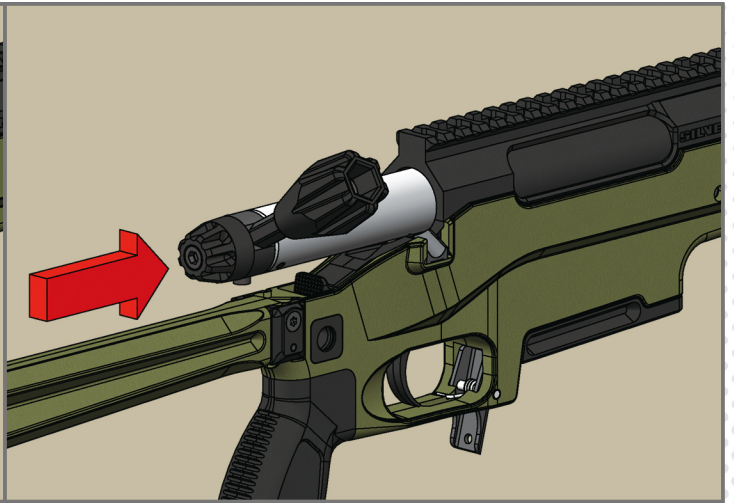

Push the bolt forward to engage a BB inside the hopup.



Lower the bolt handle to lock the bolt.

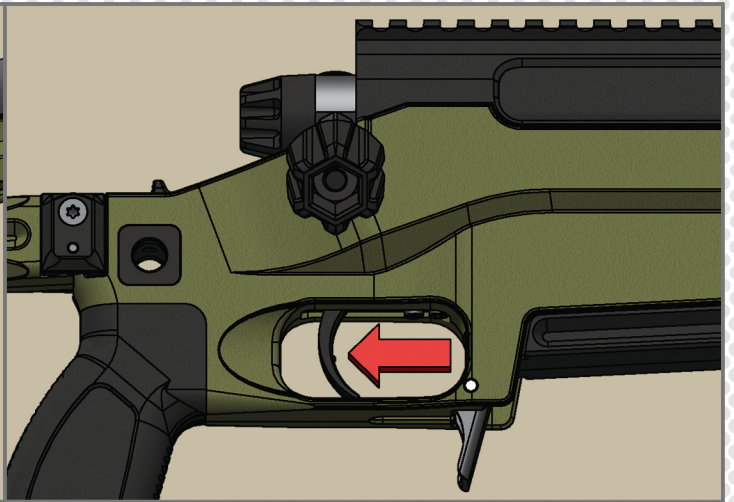

Pull the trigger to shoot. (Make sure that the safety is disengaged).

FEEDING RAMP RESET



Disengage the magazine.

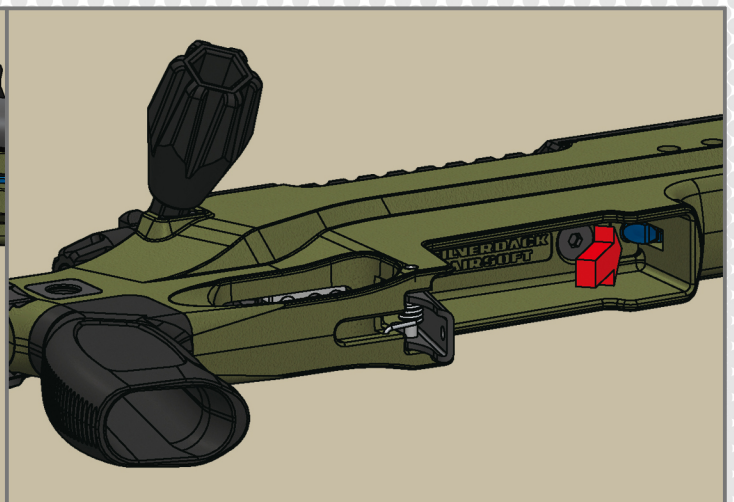

Press the feeding ramp stopper to release all the BBs inside the feeding ramp by gravity (tilt the gun at an angle with the muzzle facing upward and the trigger guard facing downward).

HOPUP ADJUSTMENT

Each «click» is increasing/decreasing the hopup preload by 15 μm . There are 50 positions for the hopup wheel, covering 750 μm of nub travel. You can add 500 μm of preload by removing the shims bellow the hopup wheel (for LS only).

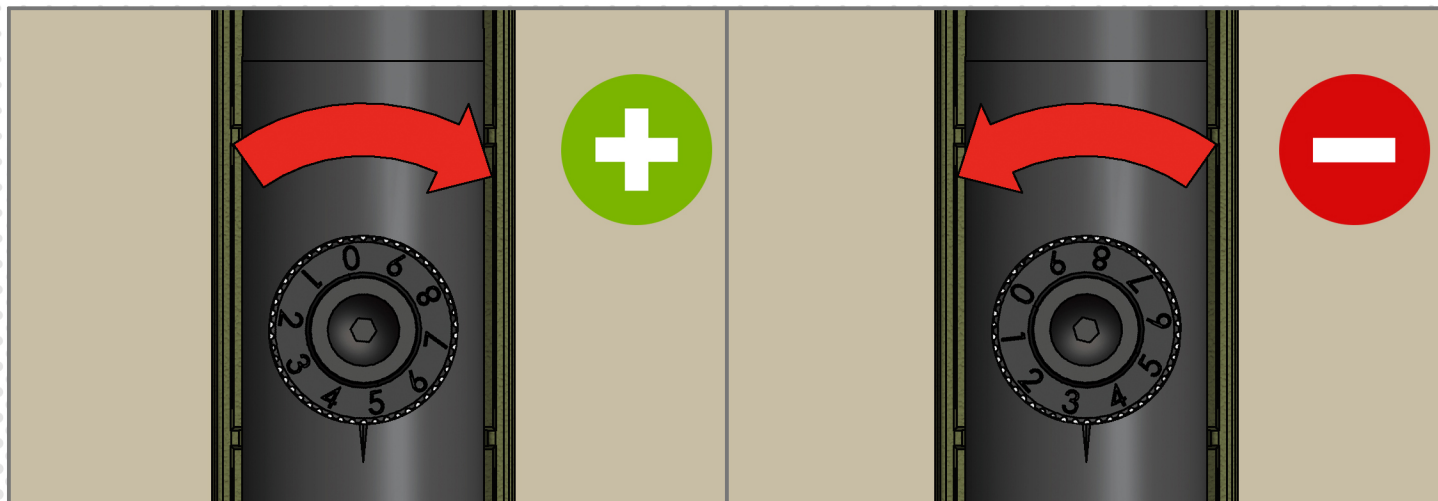

Turn the Hopup in clockwise direction to increase Hopup effect.

Turn the Hopup in counterclockwise direction to reduce Hopup effect.

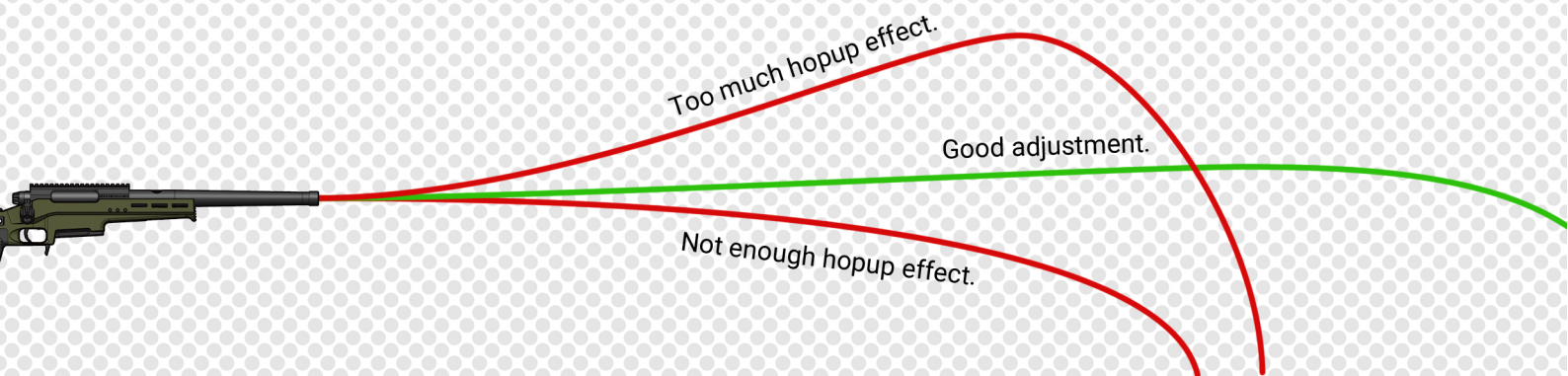

WARNINGS

- Hopup adjustment needs to be done every time you change the BBs mass or the muzzle energy.
- Excessive hopup adjustment will jam the gun.
- In case of jam
 1. remove the magazine,
 2. turn the hopup wheel to «0»,
 3. cycle the bolt,
 4. shoot in a safe direction.
- Hopup adjustment may affect your muzzle energy: always check your muzzle energy after adjusting your hopup using in-game bbs and make sure it is within the limits of your local law/rules.
- It is mandatory to keep your hopup clean and dry to be effective.
- You can switch from the position «9» to the position «0», but you cannot do the opposite.
- To avoid any sidespin, be sure to hold your rifle straight before to pull the trigger.



ADVANCED SETTINGS & ERGONOMICS

To help you with the ergonomic and advance settings, please check out our YouTube channel for the tutorials. Scan the QR code on this page to access our YouTube channel.

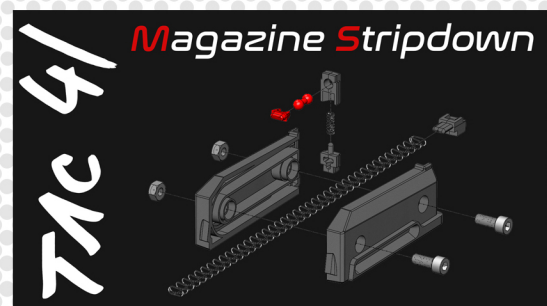
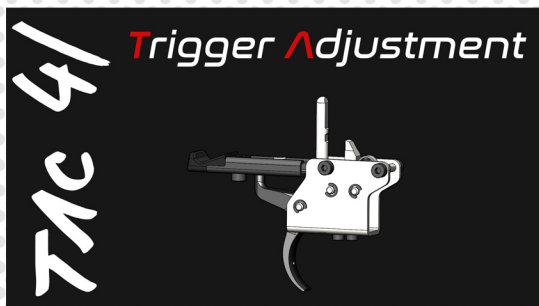



EXPLODED VIEWS

Scan this QR code to access the detailed exploded views of the T41 LITE Sport.



T41-0200-14
330 MM
SPORT
BARREL



T41-0100-05
POLYMER
RECEIVER



T41-0500-01
TRIGGER
GROUP



T41-2100-04
COUPLER

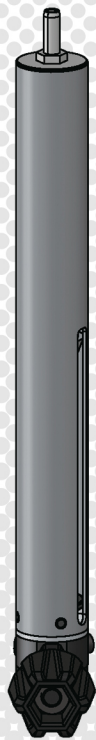

T41-0300-10
ALUMINIUM
BOLT

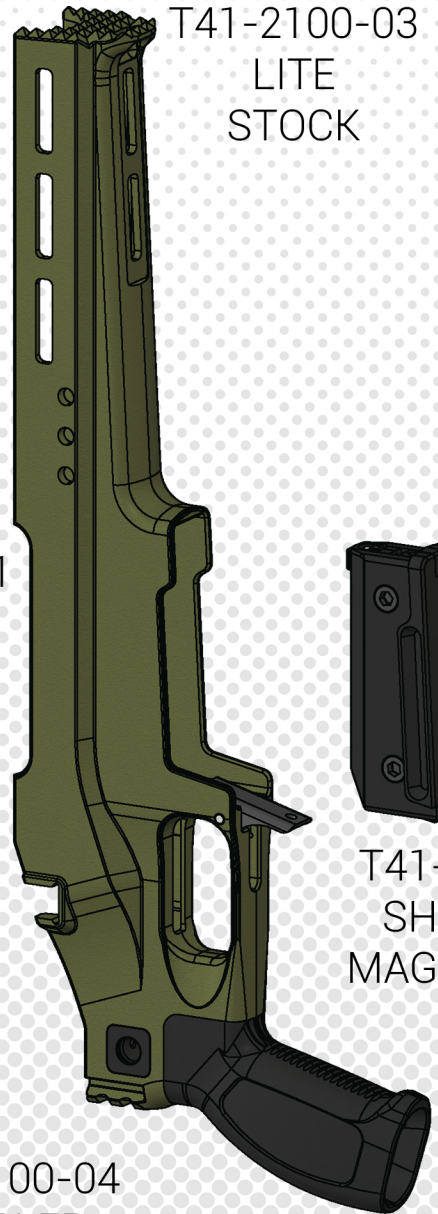

T41-2100-03
LITE
STOCK

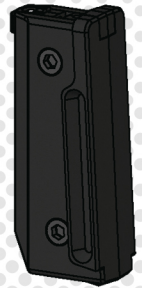

T41-1000
SHORT
MAGAZINE

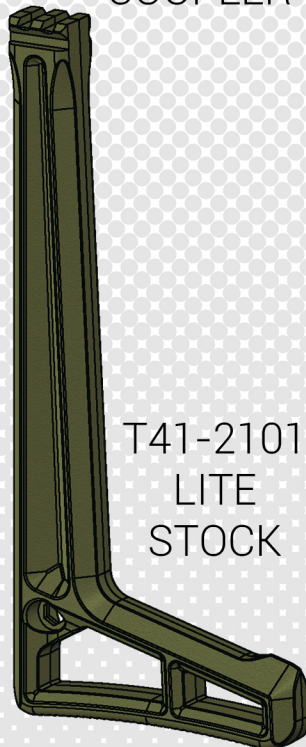

T41-2101
LITE
STOCK

Scan this QR code to access the detailed exploded views of the TAC-41 LITE.



MATERIALS / MASS / SIZE / CAPACITY

	Aluminium Receiver	Polymer Receiver	Outer Barrel	Inner Barrel	Standard Hopup	Sport Hopup	Stainless Steel Bolt	Aluminium Bolt	Polymer Stock	Aluminium Chassis	Lite Stock	Cheekpad (A/P)	Buttplate (A/P)	Trigger Box	Spring Guide Stopper	Safety	Trigger Guard	Magcatch	BB Feeding Ramp	Magazines	Screws	O-rings
Aluminium 6000 Series	■		■		■		■	■	■	■		■										
Aluminium ADC-12		■												■								
Steel CR1018							■	■	■	■	■				■		■	■				
Stainless Steel SS304							■	■	■	■	■			■	■							
Steel 10.9																					■	
Brass				■																		
Nylon PA6-GF15		■			■	■	■	■	■	■	■	■	■				■	■		■		
ABS					■	■	■	■	■	■	■	■	■									
PC						■								■								
POM	■																		■			
NBR							■	■	■	■			■									■
Silicon 60°					■	■																

ASSEMBLY #	ASSEMBLY NAME	[gram]
T41-0100-00	ALUMINIUM RECEIVER	349
T41-0100-05	POLYMER RECEIVER	186
T41-0200-02	BARREL 510 mm	486
T41-0200-06	BARREL 330 mm	362
T41-0200-10	SPORT BARREL 510 mm	436
T41-0200-14	SPORT BARREL 330 mm	312
T41-0300-00	STAINLESS STEEL BOLT	474
T41-0300-10	ALUMINIUM BOLT	270
T41-0400-04	POLYMER STOCK	1307
T41-0500-00/04	TRIGGER GROUP	126
T41-0600-00	LONG MAGAZINE	139
T41-1000-00	SHORT MAGAZINE	79
T41-1100-00	ALUMINIUM FOLDABLE CHASSIS	1391
T41-2100-05	LITE STOCK	693
TAC-41 <i>P</i>	TOTAL	2821
TAC-41 <i>PS</i>	TOTAL	2404
TAC-41 <i>A</i>	TOTAL	2841
TAC-41 <i>L</i>	TOTAL	2083
TAC-41 <i>LS</i>	TOTAL	1666

Mass tolerances: +/- 0.2 %

SIZE	MIN. [mm]	MAX. [mm]
TAC-41 <i>P/PS</i>	1095	1155
TAC-41 <i>P/PS</i> inner barrel		510
TAC-41 <i>A</i> (folded)		682
TAC-41 <i>A</i> (unfolded)	922	1022
TAC-41 <i>A/L/LS</i> inner barrel		330
TAC-41 <i>L/LS</i>		916

Size tolerance: +/- 0.2 %

CAPACITY	[obs]
Short magazine	48
Long magazine	110
Feeding ramp	20

DIGITAL VERSIONS

You can download the PDF version of this manual by scanning the QR codes below. If the manual is updated, these links will direct you to the latest versions. If you would like to contact us about your TAC-41, or if you would like to receive news on this product line, please contact us at info@silverback-airsoft.com with your serial number as a reference.



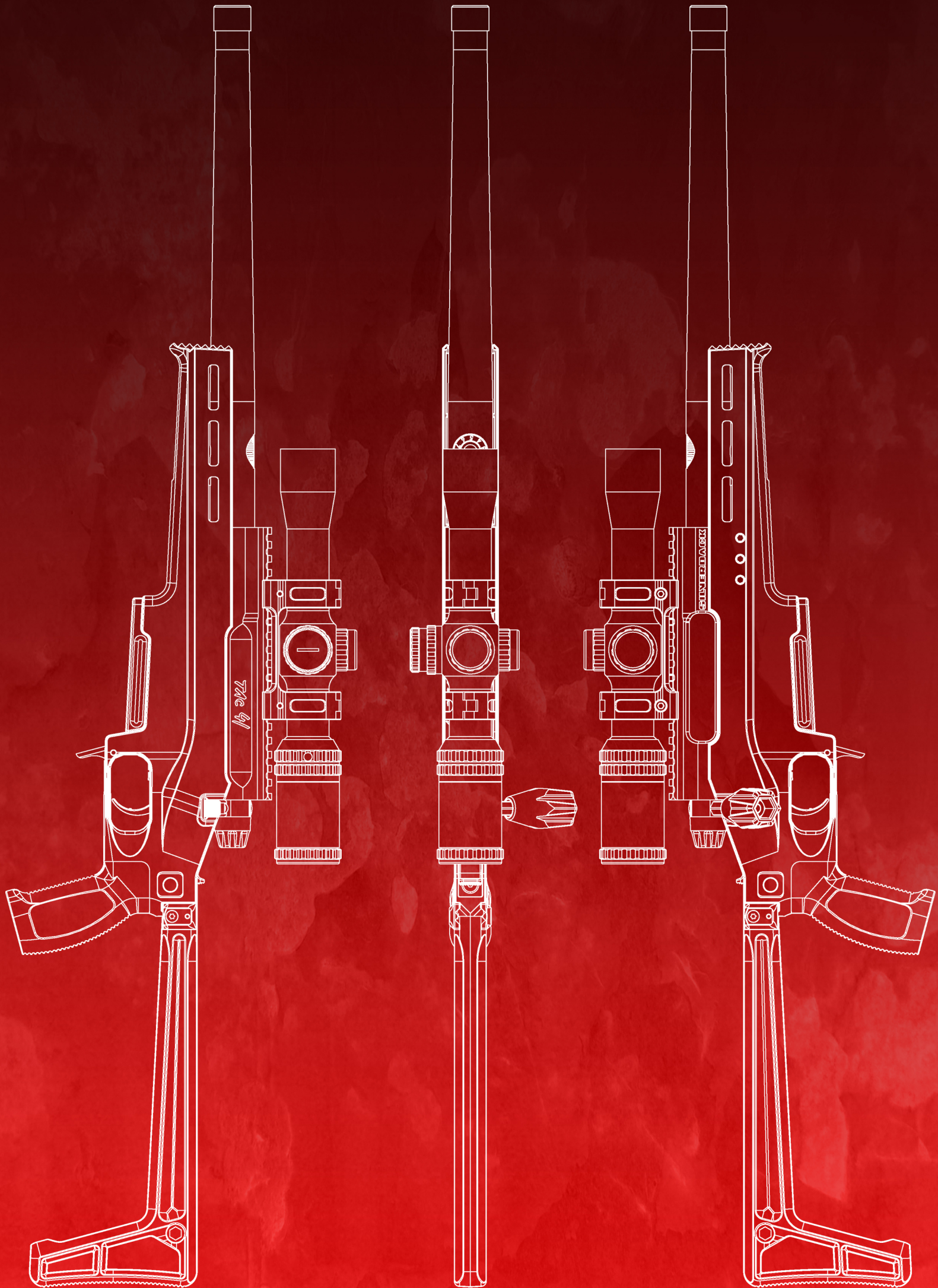



January 2024 - Made in China

SILNERBACK AIRSOFT